



BRAND
HYDRAULICS Co.

Made in the Heartland of America
Serving the World

Engineering & Manufacturing Solutions

HPV4

4-Way Directional Control Valve

Specifications:

- Rated for 0-5 gpm (0-19 lpm)
- Rated for 6000 psi (414 bar)
- Weighs 1.25 lbs. (0.6 kg)
- Porting: 1/4" NPT or #4 SAE
- 30 in lbs (3.4 Nm) to turn HPV4 spool @ 3000 psi (207 bar)
- 15 degree of rotation before work ports open to pressure or tank
 - 30 – Micron filtration recommended



PHPV4

PHPV4D



ISO 9001:2008 WITH DESIGN
Certificate #02.002.1



402.344.4434 • www.brand-hyd.com

HPV4 4-Way Directional Control Valve

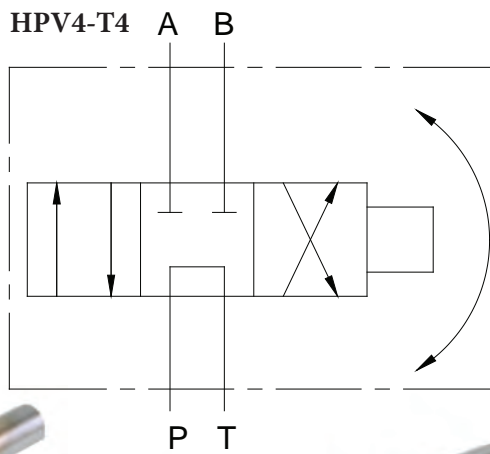
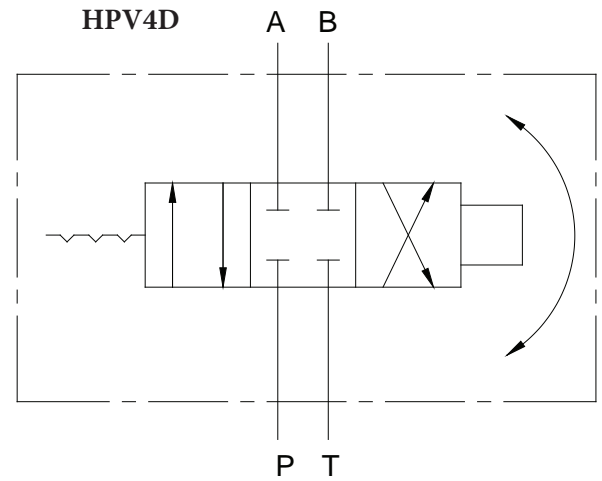
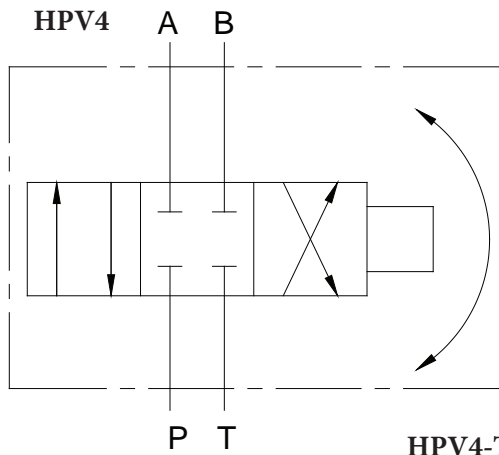

MATERIALS:

- Durabar Gray Cast Iron Body
- Buna N O'Rings
- IOSSO Plated Steel Spool

FEATURES:

- SMALL AND COMPACT to fit your design requirements.
- CROSS HOLES IN SPOOL reduce torque required to rotate the spool.
- PRECISION GROUND IOSSO PLATED SPOOL that assures long life.
- OPTIONAL #4 SAE PORTING for a better seal between the body and the fitting.
- OPTIONAL T4 SPOOL allows customer to send oil from P to T in the neutral position.
- OPTIONAL THREE-POSITION DETENT to hold the spool in either active position or neutral.

HPV4 – GENERAL INFORMATION:

The Brand, HPV4 directional control valves are small and compact. The HPV4's were designed primarily for use with hand pumps and other low flow applications where size weight and appearance are important. Three-position detent (D) holds the spool in neutral or either active position. Closed center (standard) blocks all ports when in neutral. Tandem center (T4) sends oil from P to T when in the neutral position. The T4 spool should not be used for flows of 4 gpm and greater because the pressure drop increases significantly.

HPV4 – CREATING A MODEL CODE FOR HPV4'S:

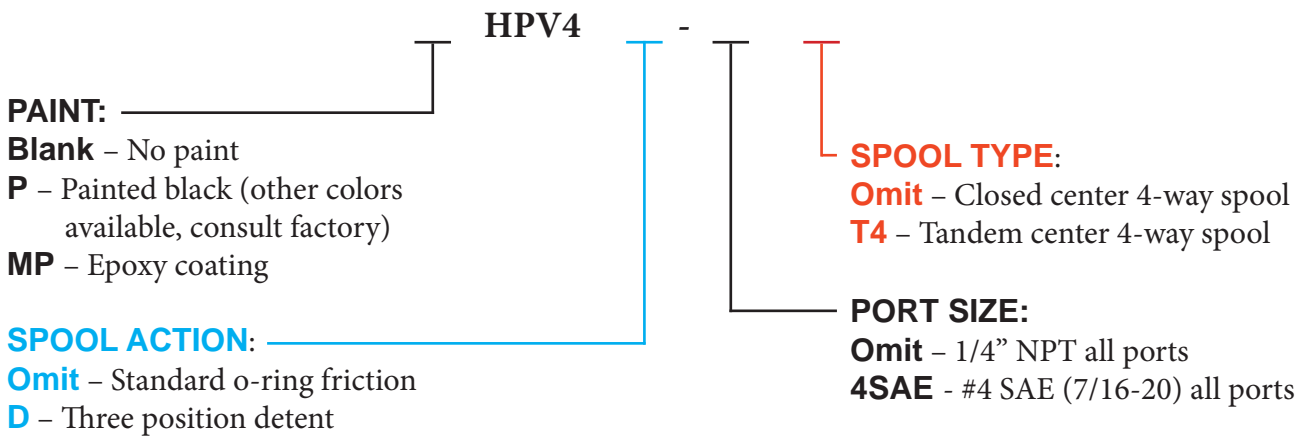

HPV4 – COMPLETE LIST OF OPTIONS AND ACCESSORIES:

- HPV-3D..... Three-position friction detent kit.
- HPV4-K..... Seal kit for HPV4.

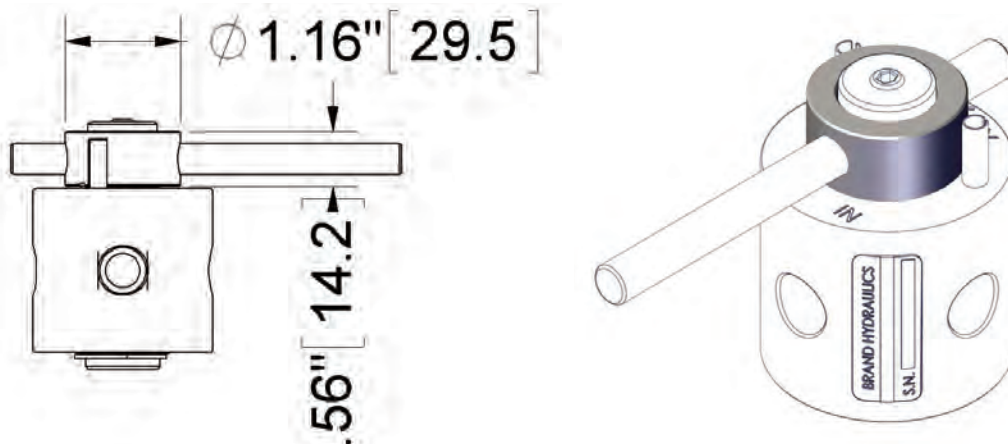

HPV4 4-Way Directional Control Valve

HPV4 - FLOW AND PRESSURE INFO:

Pressure Drop VS. Flow for P to A or B

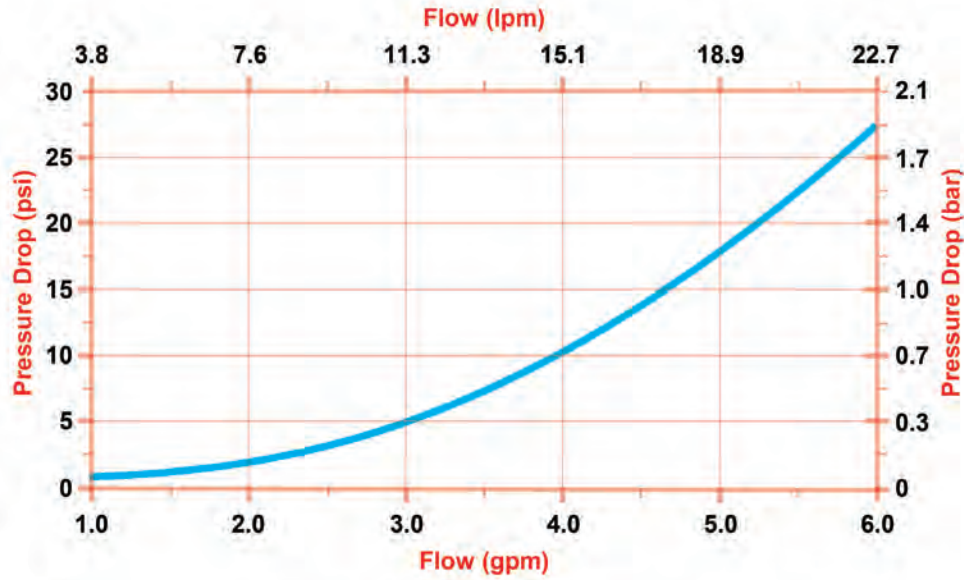

Pressure Drop VS. Flow for T4 Spool

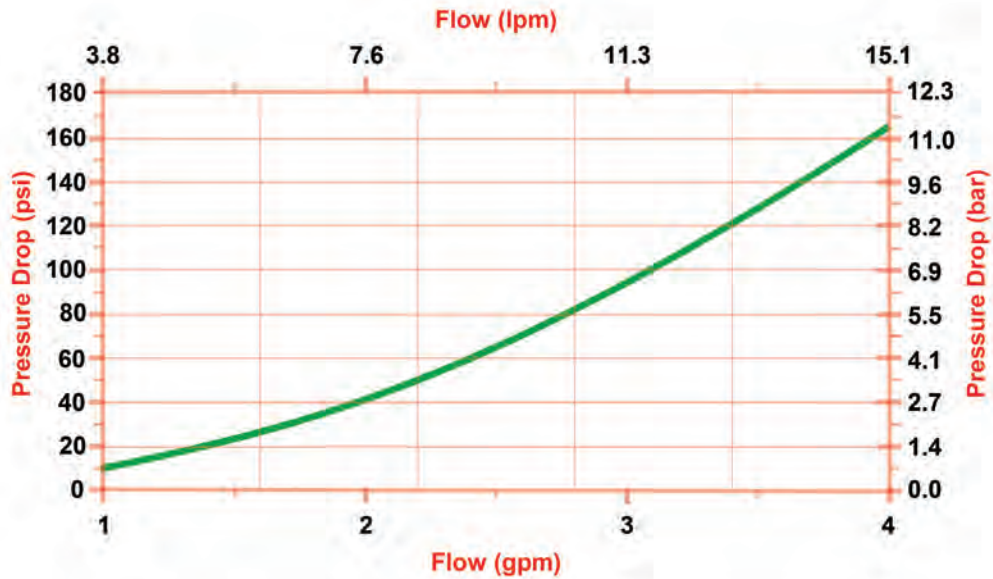

DIMENSIONAL DATA: inches & [millimeters]

